

Sal-Tech Easy Packaging Packaging Solutions Heat Sealing



WE KEEP THINGS TOGETHER

**Machines,
Tools and
Materials**



Sal-Tech Easy Packaging



Sealing – Bags & Pouch

Manual-Impulse-Heat Vacuum

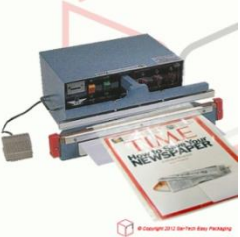

Positioning bulk products into pre made bag containers. Often manually positioned but also automatically and then supported with semi auto to fully auto bags sealing equipment.

Typisk udstyr for posesvejsning og plastsvejsning:

			
<u>Håndbetjent Posesvejer</u> <u>STEP-300HI</u>	<u>Semi Automatisk</u> <u>Impulssvejer</u> <u>STEP-455AI</u>	<u>IP bar svejser</u> <u>STEP-450IP</u>	<u>Rullesvejer</u> <u>STEP-801HW</u>

Proces:

Det emne man ønsker at svejse eller lukke, anbringes mellem kæber, hvorefter processen startes og materialet svejses, afkøles og evt. klippes af på ønsket længde afhængig af valgt posesvejer eller plastsvejer.

Posesvejsere virker ved varme enten konstant eller ved impuls under aktivering. Processen kaldes også plast svejsning, PE svejsere, poselukkere og de kan alle anvendes til svejse af varmsvejsbare materialer som f.eks.:

Hvad kan man pakke med en posesvejer:

Alt fra magasiner, aviser, blade, bøger, frugt, grønsager, postkort, julepynt, skruer, beslag, væsker, pulver, krydderier, slik, kaffe, te, ris, gryn, cremer, brød, kager mv. Det anbefales ikke at svejse materialer der ved afdampning er giftige eller medføre ubehag ved indånding, uden at det udføres under korrekt ventilerede forhold.

Pose og Folie Typer:

- LDPE Poser
 - 25my standard program
 - 50my standard program
 - 70-90my de kraftige, standard til de specielle
 - Og alle de specielle lavet på dimension, med tryk, tykkelse mv.
- Folie Materiale typer:
 - LDPE Low Denisty Polyethylene med varianter
 - Polyethylene Pliofilm P.V.A.
 - Polyurethane Kel-F Tivac
 - Polyvinylchloride Polyflex Saran
 - Polypropylene Mylar Nylon
 - Poly coatede metal/aluminiums laminater.
 - Og alle andre varmsvejsbare folietyper.
- Folie geometri
 - Rørfolie i forskellige bredder og tykkelser
 - Planfolie, centerfoldet i forskellige bredder og tykkelser

Posesvejsere, Impulssvejsere, Konstant temperatur svejsere, anvender svejsetråde til at foretage opvarmningen. Disse findes i typiske bredder 2, 5 og 10 mm fladtråde samt rundtråde med forskellig diameter. Rundtråd anvendes som skæretråd.

Svejse temperaturen ligger i intervallet 180-280 grader

Apparat typer - Følgende udstyr finder anvendelse:

Håndbetjente Impulssvejsere, Poselukkere, Posesvejsere.

Emnet anbringes mellem kæber der lukkes manuelt omkring emnet, hvorefter svejsning udføres i det indstillede tidsinterval.

- STEP-N00HI: Svejse bredde 2 mm gange længde N = 100, 200, 300, 400, 600, 800 mm
- STEP-N05HI: Svejse bredde 5 mm gange længde N = 100, 200, 300, 400
- STEP-N02or05HC: som ovenfor men med "Cutter" kniv funktion
- STEP-N02or05HCG: som ovenfor men med kniv og holdemagnet funktion. Her er der styring for regulering af svejse- og køletiden.

Semi automatisk Impulssvejsere, Poselukkere, Posesvejsere:

Emnet anbringes mellem kæber der lukkes semi automatisk omkring emnet, hvorefter svejsning udføres i det indstillede tidsinterval med efter følgende køletid.

- STEP-NN0AI: Svejse bredde 2 mm gange længde NN = 350, 450, 600 mm
- STEP-NN5AI: Svejse bredde 5 mm gange længde NN = 350, 450, 600 mm
- STEP-NN5VA: Vakuumbredde med Svejse bredde 5 mm gange NN = 450, 600 mm

IP Bar svejsere:

Emnet anbringes mellem kæber der lukkes manuelt omkring emnet, hvorefter svejsning udføres i det indstillede tidsinterval samt af skæring af overskydende folie.

- STEP-NN0IP: Der svejses med rundtråd gange længde NN = 450, 600, 800 mm

Rullesvejsere:

Emnet anbringes på en plan flade, hvorefter svejsning kan udføres ved at rulle med svejseren henover den ønskede svejse søm. Der svejses med konstant varme.

- STEP-80NHW, svejse bredde:
 - N = 1 bredde: 5mm
 - N = 2 bredde: 1mm
 - N = 3 bredde: 10mm

Alle de andre typer og varianter:

- Fod betjente svejsere
- Vertikale svejsere
- Bånd svejsere
- Vakuumbredde svejsere

Reservedele:

En vigtig sliddel på en posesvejsere er teflon beskyttelses folien. Teflon bruges til at beskytte varmetråden for plasten således der ikke overføres plast partikler til svejse tråden hvorefter dette vil brænde af og danne aske/slagger. Opbygninger af teflon beskyttelse er forskelligt fra maskine type og de enkeltes manual kan studeres for at se den korrekte opbygning.

Sal-Tech Easy Packaging lagerføre et bredt program af standard reservedels kit til posesvejsere, check vores hjemmeside under: Reservedele til STEP, Mercier, TW brand Impulssvejsere. Mange af disse reservedele passer til andre typer solgt.

STEP IMPULSE HAND Budget SEALERS

Quality impulse sealers produced in the China. Chose the sealing length and width that fit your demand, typically made less sturdy and are lighter.

Impulse Sealers Budget

Type welding length	Item No.	Description
STEP-100HI-Budget	49100010	2mm welding wire 230 V – 50 Hz
STEP-200HI-Budget	49100020	
STEP-300HI-Budget	49100030	
STEP-400HI-Budget	49100040	



STEP IMPULSE HAND High End SEALERS

Quality impulse sealers are made by the #1 selling sealer producer in the Taiwan. Ideal for multitude of applications, made of durable metal and light blue color. Makes excellent air and water tight seals on materials listed below:

- Polythylene Pliofilm P.V.A.
- Polyurethane Kel-F Tivac
- Polyvinylchloride Polyflex Saran
- Polypropylene Mylar Nylon
- And all other heat sealable material.
- Chose the sealing length and width that fit your demand.



Specifications						
Model	STEP-200HI	STEP-205HI	STEP-300HI	STEP-305HI	STEP-400HI	STEP-405HI
Max. Sealing	200 x 2mm	200 x 5mm	300 x 2mm	300 x 5mm	400 x 2mm	400 x 5mm
Machine Weight	2.5 Kg	2.8 Kg	3.3 Kg	3.6 Kg	4.8 Kg	5.3 Kg
Machine Dimension	320 x 80 x 215mm		430 x 80 x 255mm		530 x 90 x 270mm	
Voltage	230V / 50 Hz / Siemens Plug or Request for Other Voltage version					
STEP Item No.	49100200	49100205	49100300	49100305	49100400	49100405

Type welding length	Item No.	Description
STEP-100HI	49100100	2mm welding wire 230 V – 50 Hz
STEP-200HI	49100200	
STEP-300HI	49100300	
STEP-400HI	49100400	
STEP-105HI	49100105	5mm welding wire 230V – 50 Hz
STEP-205HI	49100205	
STEP-305HI	49100305	
STEP-405HI	49100405	



STEP IMPULSE HAND High End SEALERS with Cutter

STEP-200HC	49110200	2mm welding wire and knife 230V – 50 Hz	
STEP-300HC	49110300		
STEP-400HC	49110400		
STEP-205HC	49110205	5mm welding wire and knife 230V – 50 Hz	
STEP-305HC	49110305		
STEP-405HC	49110405		

AUTOMATIC IMPULSE SEALERS

STEP-450AI	49160450	
STEP-600AI	49160600	
STEP-455AI	49160455	
STEP-605AI	49160605	
STEP-4510AI	49164510	150my 10mm welding wire
STEP-6010AI	49166010	

Konsol for AI type 42218299 Consol for Automatic sealers

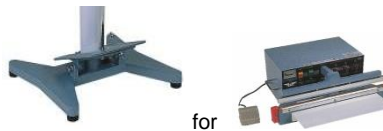
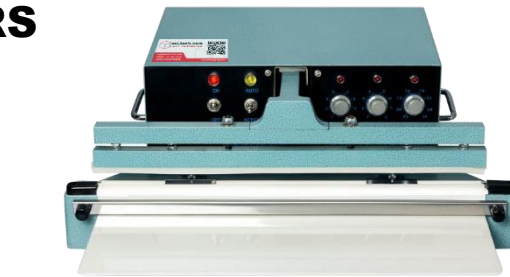

AUTOMATIC DOUBLE IMPULSE SEALERS

STEP-350AIT	49180350	
STEP-450AIT	49180450	150my 2mm welding wire
STEP-600AIT	49180600	
STEP-355AIT	49180355	
STEP-455AIT	49180455	150my 5mm welding wire
STEP-605AIT	49180605	
STEP-4510AIT	49184510	150my 10mm welding wire
STEP-6010AIT	49186010	

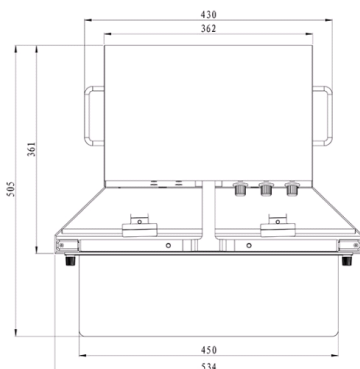
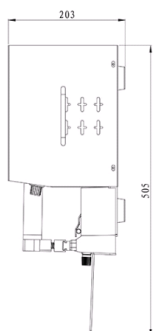
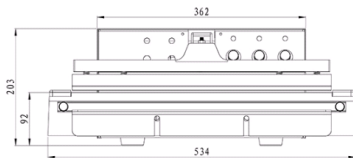

STEP FKR Series portable sealers

This lightweight and versatile portable tong sealers can be used anywhere. This is Model STEP FKR-200/300/400 and is a direct heat sealers with a Teflon coated serrated jaw. Ideal for sealing Coated aluminum foil, Kraft paper and other thick materials such as thick poly. This portable tong sealer is the best way to seal aluminum foil bags used in long term food storage. Portable tong sealer makes a perfect 200mm, 300mm and 400mm long, strong seal on poly bags and other thermoplastic material. It is easy to operate: simply place the bag or plastic case between the sealing bars, press down and release.

Features:

- Durable and portable
- Fast and Effective sealer
- 200mm/300mm/400mm Serrated Teflon Coated Jaw Heat Sealer
- Best way to seal aluminum foil bags for food storage
- Ideal for sealing Aluminum foil, Kraft Paper, other Thick Materials



PE Coated Paper | Aluminum plastic composite bag | Aluminum foil film

SPECIFICATIONS

Model	STEP FKR-200	STEP FKR-300	STEP FKR-400
Voltage(V/Hz)	110/220 50-60	110/220 50-60	110/220 50-60
Sealing Length(mm)	200	300	400
Sealing Width(mm)	12	12	12
Pre-heating(min)	1-3	1-3	1-3
Temperature (°C)	0-250	0-250	0-250
Dimension(mm)	249x200x115	249x300x115	249x400x115
Item number	49831200	49831300	49831400

STEP FKR-200
Dimensions:

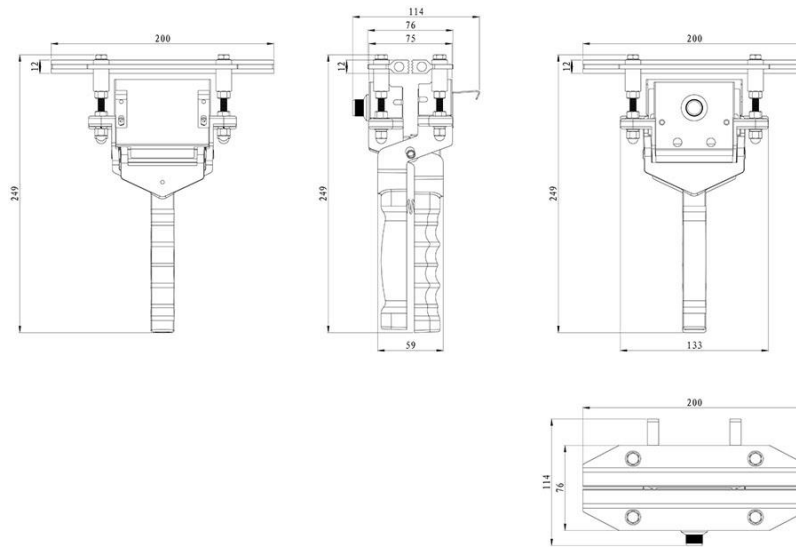

STEP FKR-300
Dimensions:

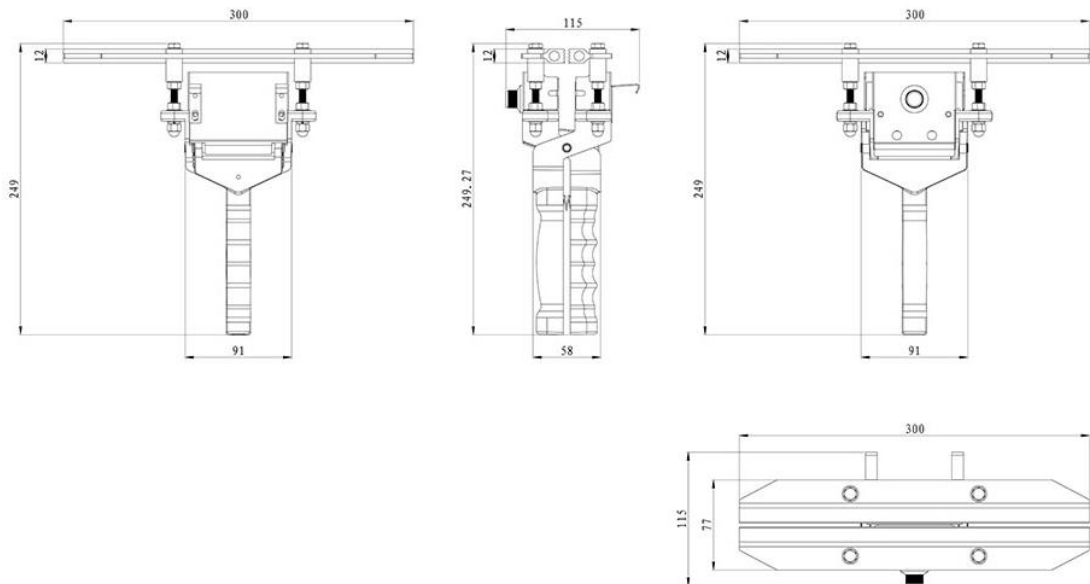

STEP FKR-400
Dimensions:

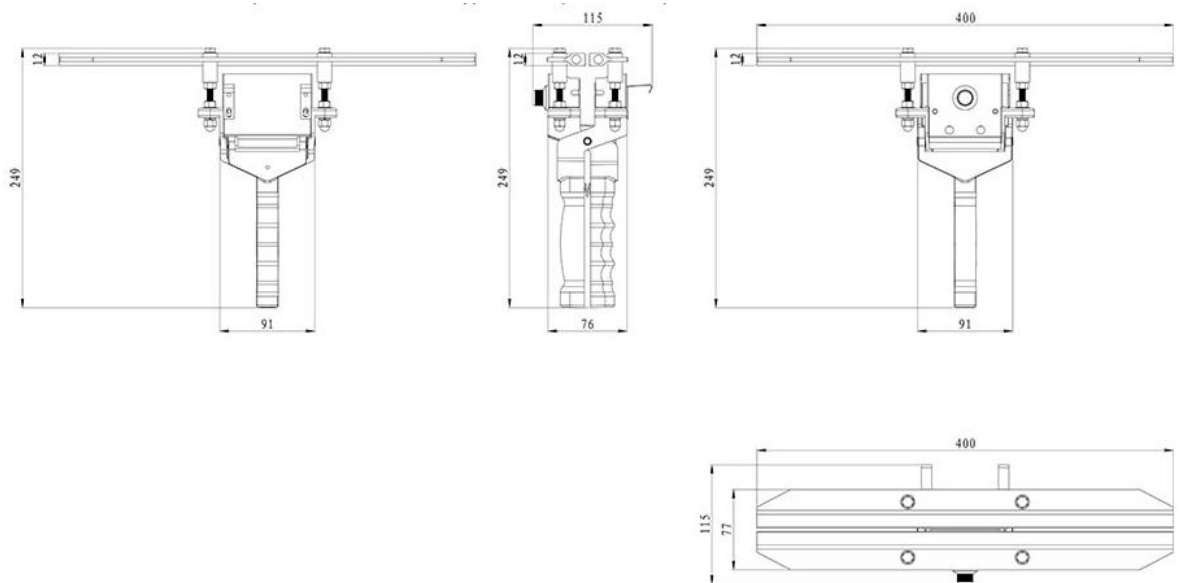

STEP DS-3010/7510FT Double Impulse Foot Sealers

Double impulse sealer suited for sealing multiple layers

- 300, 450, 600, 750mm width Foot type impulse sealer
- (Double-side sealing)
- Max. sealing: 300*10mm (450x10, 600x10, 750x100)
- Working table: 230*140mm
- Machine weight: From 25kgs
- Dimension: From 380*370*900mm
- Spare parts: heating element of 5mmx2sets
- Bag material: PE, PP - plastic bag and aluminum bag.
- Packing: 1set/ctn; 20/22kgs; 4.3'

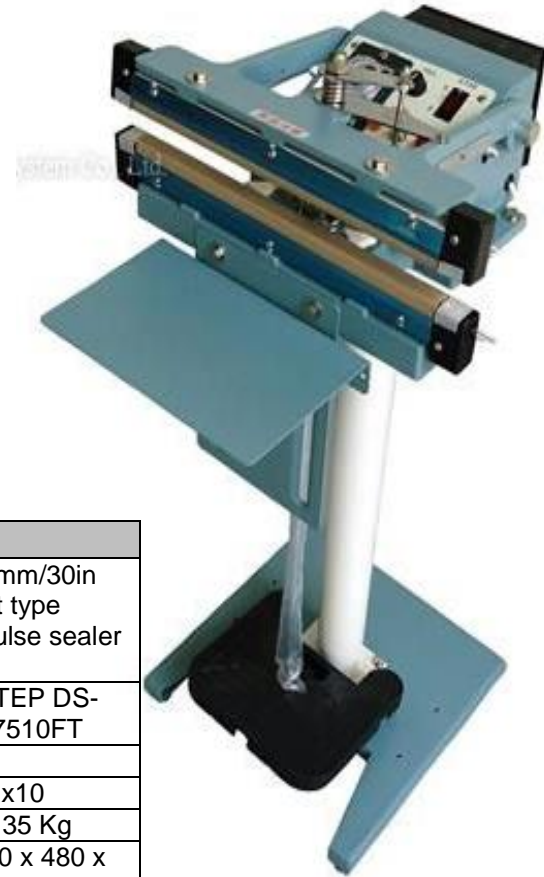

Specifications				
Description	300mm/12in Foot type impulse sealer	450mm/18in Foot type impulse sealer	600mm/24in Foot type impulse sealer	750mm/30in Foot type impulse sealer
Model	STEP DS- 3010FT	STEP DS- 4510FT	STEP DS- 6010FT	STEP DS- 7510FT
Sealing Weld Width	10mm			
Max. Sealing (mm)	300 x 10	450 x 10	600 x 10	750 x 10
Machine Weight	25 Kg	29 Kg	33 Kg	35 Kg
Dimension	380 x 370 x 900 mm	530 x 480 x 880 mm	680 x 480 x 880 mm	830 x 480 x 880 mm
Voltage	230V / 50 Hz / Siemens Plug or Request for Other Voltage Version			
STEP Item No.	49193010	49194510	49196010	49197510



STEP DS-300/750FI Series Single Sided Impulse Foot Sealers

Heating is only on one side, these units are inexpensive efficient work horse packaging machines that can seal a wide variety of packages from small single portion packets up to large heavy-duty thick materials. Using the foot pedal to activate the sealer allows hands free operation.

Features:

- Suitable for plastic bags (such as the material of PE, PP, PET) and Aluminum flat bags
- Single Heating Element
- Sealing Width is 2mm or 5mm
- Comes in
 - 12", 18", 24" and 30"
 - 300, 450, 600 or 750mm
- Made in Taiwan

Options:

- **Other Voltage Version:** 100V, 110V, 120V, 220V, 240V
- **Date coder** - for Printing the date on the bags when sealing.
- **Thermal baffle** - it is for constant heat Foot sealing machine to prevent the users touching the high temperature sealing bar.
- **Electric magnet control Foot sealing machine.**
- **Pneumatic control Foot sealing machine.**



Shown with extra equipment mounted

Specifications								
Description	300mm/12in Foot type impulse sealer		450mm/18in Foot type impulse sealer		600mm/24in Foot type impulse sealer		750mm/30in Foot type impulse sealer	
Model	STEP DS-300FI		STEP DS-450FI		STEP DS-600FI		STEP DS-750FI	
Sealing Weld Width	2mm	5mm	2mm	5mm	2mm	5mm	2mm	5mm
Max. Sealing (mm)	300 X 2	300 X 5	450 X 2	450 X 5	600 X 2	600 X 5	750 X 2	750 X 5
Machine Weight	16 Kg		18 Kg		21 Kg		22 Kg	
Dimension	380 x 480 x 880 mm		530 x 480 x 880 mm		680 x 480 x 880 mm		830 x 480 x 880 mm	
Voltage	230V / 50 Hz / Siemens Plug or Request for Other Voltage Version							
STEP Item No.	49170300	49170305	49170450	49170455	49170600	49170605	49170750	49170755

Large impulse sealers

Type welding length	Item No.	Description	
STEP-600HI	49150600	Big opening on welding arm 2mm welding wire For heavy duty use Bags up to 150 my	
STEP-800HI	49150800		
STEP-1000HI	49151000		

I-BAR IMPULSE SEALER

STEP-300IP	49270300	Round wire 250 W	
STEP-450IP	49270450	Round wire 350 W	
STEP-600IP	49270600	Round wire 450 W	
STEP-800IP	49270800	Round wire 500 W	
STEP-1000IP	49271000	Round wire 700 W	

LARGE IMPULSE SEALERS WITH CUTTER & STAND

STEP-600SFTD	49820600	Big opening on welding arm 3-5mm welding wire For heavy duty use Bags up to 200 my Heating time from 02 to 2,0 seconds. With cutter, stand and foot pedal. 600mm has 750w	
STEP-800SFTD	49820800		
STEP-1000SFTD	49821000		

STEP-1505HC Hand Type Impulse Sealer with Cutter

STEP-1505HC Hand Type Impulse Sealer with Cutter is an ideal for PE, PP, plastic 60" Hand type impulse sealer with cutter that has steel housing with painting.

Sample Image

Features:

- High quality sealing machine With Cutter
- Safety
- Easy to use
- Timer automatically controls the Sealing Time. (If there is no Timer, then the Sealing Time is manually controlled.)
- Sealing is followed by Cooling (the working Time is needed for sealing to set) and this affects the beauty of the seal.



SPECIFICATIONS

Model	STEP-1505HC hand type impulse sealer with cutter
Item Number	49111505
Heating Element	5mm
Voltage	230V
Power	2500W
Max. sealing	1500*5mm
Heating Time	0-1.5 sec
Max. Temp	250°C
Machine Weight	36kgs
Dimension	190*24*35CM
Packing	1set/36kgs/37kgs/6.80

ROLLER IMPULSE SEALER

Type welding length	Item No.	Description	
STEP-802 HW	49250801	Hand wheel roller sealer 1mm	
STEP-801 HW	49250802	Hand wheel roller sealer 5mm	
STEP-803 HW	49250803	Hand wheel roller sealer 10mm	

STEP Foot Type Constant Heat Sealers

makes constant heat and results in a very wide hermetic seal unlike impulse sealers. The sealing is from both sides (lower element and upper element) and then makes a knurled cross hatch pattern which produces an extremely strong seal. These machines have an additional benefit of having very minimal spare parts requirements over their life.

Features:

- Width of Sealing Line is 10mm
- Available for aluminum bag, tinfoil bag and sterilization bag
- Comes in various Sizes 220mm, 250mm, 300mm & 450mm

Options:

- Heating Isolation Board
- Bag width adjustment
- Electric Magnet for Pedal Switch Control
- Pneumatic Equipment for Pedal Switch Control
- Date coder
- Extra-longer sealing machine
- Voltage Version: 100V, 110V, 120V, 220V, 240V



Specifications				
Model	STEP DS-220FD	STEP DS-250FD	STEP DS-300FD	STEP DS-450FD
Description	220mm Foot Type Constant Heat Sealer	250mm Foot Type Constant Heat Sealer	300mm Foot Type Constant Heat Sealer	450mm Foot Type Constant Heat Sealer
Max. Sealing	220mm x 10mm	250mm x 10mm	300mm x 10mm	450mm x 10mm
Machine Weight	12.50 Kg	13 Kg	13.50 Kg	14 Kg
Dimension	320 x 340 x 900 mm	320 x 340 x 900 mm	320 x 340 x 900 mm	480 x 340 x 900 mm
Voltage	230 V / 50 Hz / Siemens Plug or Request for Other Voltage Version			
STEP Item No.	49172210	49172510	49173510	49174510

STEP 900ECA Hand operated Automatic Sealer with cutter



STEP 900ECA Hand operated Automatic Sealer with Cutter is intended for the sealing of polyethylene and polypropylene film bags.

Electronically controlled impulse sealing. Impulse sealing requires congealing time.

PE, PP, OPP, PVC, POF... are ideal materials for single sealing.

Application:

1. When you press the Handle, the upper bar will be sucked by the electromagnet.
2. Time is up after sealing and congealing.
3. Cut the bag edge or tube film using the knife.
4. To lift the sealing bar, press the release button.

Specification	
Model	STEP 900ECA Hand-operated Automatic Sealer with Cutter
Voltage	220V
Power (Watt.)	1400W
Amps.	15 A
Max. sealing	900 *2.7mm/5mm
Heating Time	0-1.5 sec.
Max. Temperature	250 °C
Dimension	976*270.6*217cm
Weight	32.1 KG
Item No.	49910900

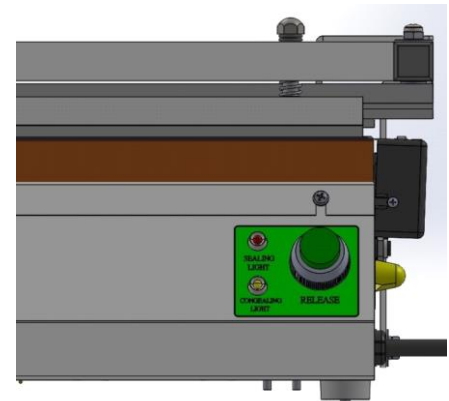

STEP Bag Blower / Opener

The STEP Bag Blower / Opener is designed to quickly and effectively open pre-made poly bags for product filling. The machine is suitable for placing buns, breads, etc. in a pre-made bag - recommended for the food industry.

It is economical and easy to use with its table-top design.

Features:

- The bag holder separated design
- Use a single layer bag mouth
- This machine can automatically open the bag and put the product swiftly
- Smooth and quiet operation of the fan motor
- Stainless steel housing makes it safer and cleaner for food packaging.
- Bag can be changed quickly during operation.
- The stable airflow opens the bag smoothly without hassle.
- Easy to use: Easy to operate without risking safety in the workplace
- Durable device that is made for basic to intermediate bag packing requirements with the help of an operator
- A reliable and consistent tool for bagging buns, breads, and many more

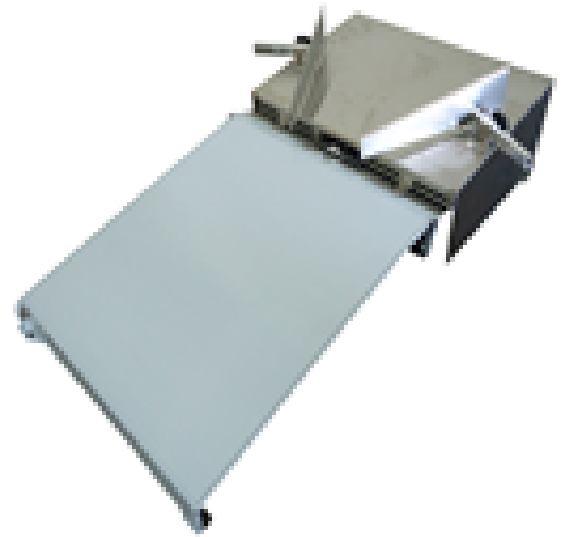

Technical Details	
Sealer width	400mm (16")
Wind speed	20CFM
Power	50W
Voltage	230V 50 Hz Optional 110V 60Hz
Stainless Steel Plate	SUS304
Item number	49230400 (49230400-110 for 110V 60Hz version)



STEP Bag Blower HBB

STEP bag blower HBB is a bag opening machine suitable for filling breads and buns in a pre-made wicket bag. This is also improved with a capacity to be integrated to a production line – closing the bag or set after the out feed of a bread slicer. Ensuring a clean and safe work environment for both customer and worker satisfaction.

This STEP Bag Blower HBB machine is a semi-automatic equipment made to ease the loading of goods to a pre-made bag. Combining ergonomic and economic solution as it aids in manual processing of merchandise while keeping a reasonable price tag. Designed impeccably that could be simply integrated with a production line, creating more affluence when it comes to production.

Features:

- Can be integrated in production
- Easy to operate and ergonomic
- Low Maintenance
- Durable device for basic to intermediate bag opening and filling
- Reliable

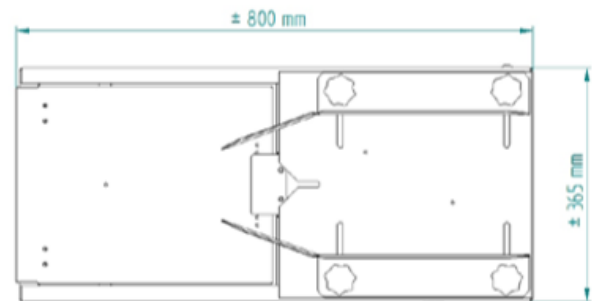
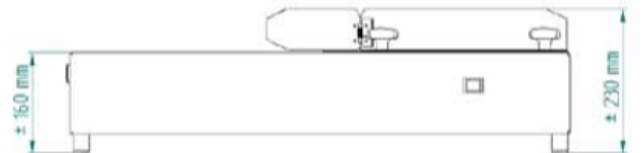

SPECIFICATIONS:

Weight	25kgs
Capacity	Depends on the operator
Product Range: Length	140mm – 320mm
Product Range: Width	80mm – 200mm
Product Range: Height	70mm – 150mm
Pneumatic Connection	Not needed (air fan)
Electrical Requirements	220V, 50Hz, 1P,N O, 1kW
Item no.:	49230700

Options:

- Bag blower of width up to 300mm
- Stainless Steel housing beneath bag blower
- Tab-lock closing machine with bracket attached to the frame



STEP DS-K500 HAND FOOD WRAPPERS

is a food hand wrapper using 20" Film Wrap, product is made of Stainless-Steel outer housing. Cling Film is positioned inside the machine to keep parts clean and dirt free and to enhance freshness, taste, appearance and smell of food.

Features:

- Available for PE, PVC film
- Easy to operate, fast wrapping and time and energy saving
- Outer housing is made of Stainless Steel, anti-rust material



Specifications	
Model	STEP DS-K500
Film position	Inside
Max. film size	500mm x 500 meter
Machine weight	3.8 Kg
Dimension	540 x 215 x 175mm
STEP Item No.	49240502

STEP DS-45

Hand Wrappers Series - is an Electric Food Hand Wrapper built and designed to ensure that heat cutting is done without fumes, to eliminate chances of contamination on the products being wrapped. It comes with 2 choices, depending on your preference on the film position, both products designed to keep parts clean from dirt to enhance product life longer.

Features:

- Outer housing is made of Anti-rust, pre-painted AL-ZN alloy steel
- Heating board gives a tight seal
- Available for PE, PVC film
- Easy to operate, fast wrapping and time saving
- Widely used for packaging food to preserve the freshness taste, appearance and smell



Specifications		
Model	STEP DS-B45	STEP DS-U45
Film position	Inside	outside
Max. film size	460mm x 500 meter	
Machine weight	7 kgs	
Dimension	500 x 450 x 170mm	500 x 600 x 120mm
Voltage	230V, 50 Hz, Siemens Plug or Request for other Voltage version	
STEP Item No.	49240145	49240245

STEP FRM-980ZQ Band Sealer with Vacuum in Painted or Stainless Steel

Advantages:

- Fully enclosed guard for CE safety standards
- Swing suction nozzle
- Simple panel for setting and operation
- The height of sealing head is freely adjustable
- The height of the conveying table can be adjusted
- The Head can be tilted
- Has a fashionable design
- Gas- Flushing; Air Suction machine

SPECIFICATIONS	
Voltage:	AC 220/50 110/60
Motor Power (W):	50
Sealing Power (W):	300 x 2
Printing Heating Power (W):	40 x 2
Speed (m/min):	0-12
Sealing Width (mm):	10
Temperature (Celcius):	0-300
Adjustable Angle range of conveyor:	20 Degrees
Distance from Sealing center to conveyor (mm):	38
Conveyor Size (LxW) (mm):	1054x203
Max conveyor load for Single Bag (kg):	1
Overall conveyor Load (kg):	3
External Dimension (LxWxH) (mm):	1050x550x (940-1110)
Printing Method:	Solid Ink
Paint Item no.	49802010
Stainless Steel Item no.	49802020



STEP BAND Sealers



STEP BF-900 Band Sealing machine

Industrial grade band sealer for sealing thermoplastic materials fast and easy.

Durable machine that is easy to use.

Specification:

Sealing speed: 0 to 12 meters/minute, sealing any sealable thermoplastic material

Conveyor speed: Adjustable to suit sealing speed.

Sealing width: 5-15mm

Temperature range: 0 to 300°C - Constant direct heater, automatic, 500W.

Sealing thickness: 0,02 to 0,08mm

Dimensions: 900 x 450 x 500mm

Weight: 35 kgs

Versions:

- Painted version item no.: 49800900-HPB
- Stainless Steel version item no.: 49800900-HSS

STEP FRD 1000 Band Sealer with Solid Ink Coding



Stainless steel version shown.

Industrial grade band sealer with print function for sealing thermoplastic materials fast and easy. Durable machine, that is easy to use.

Specification:

Sealing speed: 0 to 12 meters/minute, sealing any sealable thermoplastic material

Conveyor speed: Adjustable to suit sealing speed.

Sealing width: 5-15mm

Temperature range: 0 to 300°C - Constant direct heater, automatic, 700W.

Sealing thickness: 0,02 to 0,08mm

Printing no.: Less than 39 digits

Dimensions: 1000 x 420 x 350mm

Weight: 25 kgs

Versions:

- Stainless Steel Vertical item no.: 49800900-VSS
- Stainless Steel Horizontal item no.: 49801010



Painted body on request.

STEP CBS 1100 Band Sealer with print function



Industrial grade band sealer with print function for sealing thermoplastic materials fast and easy. Durable machine that is easy to use.

Specification:

Sealing speed: 0 to 12 meters/minute, sealing any sealable thermoplastic material

Conveyor speed: Adjustable to suit sealing speed.

Sealing width: 8mm

Temperature range: 0 to 300°C - Constant direct heater, automatic, 750W.

Sealing thickness: 0,02 to 0,08mm

Product weight: 15kgs maximum

Printing digit no.: Less than 17 digits

Dimensions: 1530 x 670 x 1360mm

Weight: 122 kgs

Versions:

- Stainless Steel version item no.: 49801100

STEP DBF 1300 Band Sealer



Industrial grade band sealer for sealing thermoplastic materials fast and easy. Durable machine that is easy to use.



Specification:

Sealing speed: 0 to 12 meters/minute, sealing any sealable thermoplastic material

Conveyor speed: Adjustable to suit sealing speed.

Sealing width: 5-15 mm

Temperature range: 0 to 300°C - Constant direct heater, automatic, 500W.

Sealing thickness: 0,02 to 0,08mm

Sealing height: 850mm adjustable

Product weight: 40kgs maximum

Dimensions: 1317 x 450 x 1255mm

Weight: 80 kgs

Versions:

- Painted version item no.: 49801300
- Stainless Steel version item no.: 49801310

STEP PFS 750 Large Impulse Sealer with stand

Industrial grade impulse sealer for sealing thermoplastic materials fast and easy.

Durable machine that is easy to use.

Specification:

Sealing length:	750mm
Sealing width:	8 mm
Temperature range:	0 to 300°C - Constant direct heater, automatic, 500W.
Sealing thickness:	0,02 to 0,08mm
Sealing height:	450 - 750mm adjustable
Dimensions:	1050 x 910 x 1500mm
Weight:	157 kgs
Versions:	

- Painted version item no.: 49810750

Stainless Steel version item no.: 49810760



STEP Silver Abs

This is the smallest vacuum packer, especially conceived for families. The high quality of the work, the easiness of use and the amazing level of final vacuum are the best answer to meet any domestic need to pack and protect food.

Features:

- External suction.
- Fully in polycarbonate (ABS) for a lower weight and practical purpose.
- Highly efficient Italian vacuum dry pump.
- Electrical resistance 5mm for a perfect bag seal.
- Vacuum Sensor: the machine detects the total vacuum and goes directly to the sealing phase.
- Internal cutter for bags.
- Possibility to do vacuum in appropriate containers.
- Very clear and easy control panel.

Specifications	
Material	ABS
Dimension	380x180x80 h
Sealing bar	300 mm
Vacuum Pump	Q=10/12 Ltmin
Sealing System	Impulse
Weight	Kg 2.3
Absorption	W 190
Voltage	230 V/50-60 Hz
Item No.	49751010



STEP Premium Vacuum Sealer Series

These machines are small and rather cheap and they are ideal in particular for small shops. The vacuum bag, with the product inside, is kept outside the machine during the vacuum cycle. Immediately after having created vacuum, the machine seals the bag. The percentage of vacuum reached by these machines is around 90-95% and it's preferable to pack only solid products, in order not to damage the machine which works with a dry pump. Comes in various sealing lengths to cater for your various packing needs and requirement.



STEP Premium 350 Vacuum Sealer- One of the available variations we have in our STEP Premium Vacuum Sealer Series, this vacuum sealer packing machine is recommended for small retail shops, these are compact and reliable professional machines used in packing food "live" in front of customers, with consequent benefits in terms of service and image.

Features:

- Digital Control Panel for Manual or automatic Operation
- Stainless Steel Structure protects the machine in various working conditions
- The very high vacuum percentage prevents oxygen, molds and alike to develop.

Vacuum packing is the way to go nowadays. Nobody wants to throw away the food leftovers. For those that don't possess fridges, this can be the best way to preserve food.

Recommended for any product with a limited % of humidity (Ham, cheese, coffee etc..).

Specifications:

Product Model	STEP Premium 350 Vacuum Sealer	STEP Premium 400 Vacuum Sealer	STEP Premium 450 Vacuum Sealer	STEP Premium 500 Vacuum Sealer
Sealing Bar	350 mm	400 mm	450 mm	500 mm
Vacuum Pump	Q=20/24LTmin	Q=20/24LTmin	Q=20/24LTmin	Q= 40/48 LT/min
Overall Dimension	370x260x130 h	420x260x130 h	470x260x130 h	520x260x130 h
Power Consumption	250 W	270 W	300 W	450 W
Voltage	230 V/ 50-60 Hz	230 V/ 50-60 Hz	230 V/ 50-60 Hz	230 V/ 50-60 Hz
STEP Item Number	49751350	49751400	49751450	49752500

STEP MINI SQUARE

Mini Square is the brand-new top table vacuum packing machine, synonym for compactness, reliability and elegance.

This is the ideal unit for professional catering equipment sector: its main features are represented by the incredible speed during vacuum performance and its extremely easy usage.

Features:

- Stamped stainless steel chamber
- Vac Stop, button that allows you to anticipate the end of the vacuum cycle
- Gastro container connection
- Great quality and maximum ease of use
- Openable Carter at 90° for a better service
- Automatic opening of the lid at the end of the cycle
- Auto-clean pump, process that allows the pump to clean itself by pressing a button



Specifications	
Dimension	320x500x270 h
Size of the Chamber	260 x 300 x 110 h
Sealing bar	250 mm
Vacuum Pump	Q = 8/9.6 m3h-OIL
Voltage	230 V/50-60 Hz
Item No.	49752300

STEP Square 300B Series

These are totally stainless-steel food vacuum machine, extremely flexible to be used in various situations. You choose between **300mm & 350mm** sealing width/bar they have become essential to pack a certain number of products. The bombed lid makes this very unique to use for foods requiring wider spaces.

This machine is a great asset to assist you in several fields of activity: from restaurant to gastronomy, catering, supermarkets etc.

By pre-portioning soups, sauces and completed dishes you can reduce food wastage (Sauces & liquids food, meet, fish, vegetable).

- Instant seal function
- Dry & moist food function
- Manual function



Specifications		
Model	STEP Square 300 B	STEP Square 350 B
Overall dimension	410x460x430 H	460x510x460 H
Vacuum Chamber dimension	310x350x190 H	360x400x190 H
Sealing Bar	mm 300 (1x5 mm)	mm 350 (1x5 mm)
Vacuum Pump	Q = 8 m ³ /h OIL	Q = 10 m ³ /h OIL
Control Panel	Digit 9 PRG	Digit 9 PRG
Voltage	230 V/50-60 Hz	230 V/50-60 Hz
Item No.	49752320	49752350

STEP Square 400B Series

This machine is built to securely seal product and features a robust oil pump t. You can choose between **400mm** or **450mm** sealing bars, sealing a bag in a few seconds and vacuuming it. Plus, easy-to-use, digital controls ensure user-friendly operation, while the stainless-steel exterior ensures long-lasting convenience in harsh, commercial kitchen settings.

Features:

- Long lasting oil pump that runs more quietly and quickly than a dry pump.
- Ensures efficiency, but a reliable, secure seal after every use.
- Controls are designed for ultra-simple use, with arrow buttons to increase or decrease the duration of the seal or vacuum process.



Model	STEP Square 400B	STEP Square 450B
Overall Dimensions	510x560x480 H	560x610x480 H
Vacuum Chamber Dimensions	10x450x220 H	460x500x220 H
Sealing Bar	mm 400 (1x5 mm)	mm 450 (1x5 mm)
Vacuum Pump	Q = 20 m ³ /h OIL	Q = 20 m ³ /h OIL
Control Panel	Digit 9 PRG	Digit 9 PRG
Voltage	230 V/50-60 Hz	230 V/50-60 Hz
Item No.	49752410	49752450

STEP Square Dual Series

These are Vacuum Packing machines with wheels on chamber type, with 2 sealing lengths 2 choose from **450mm & 550mm**. These are professional packers especially suggested for medium-sized enterprise and built to be solid and allows the highest peak of productivity.

Features:

- It is suitable for medium to large sized activities that require constant operational activity.
- This Italian-made chamber vacuum packer is made of stainless steel, guaranteeing solidity and durability over time.
- It provides the possibility of connecting a printer for labels.

This type of vacuum packing machines has an automatic processing of vacuuming, sealing which is used in vacuum packaging of the food. Suitable for all types of foods such as meat, fish, vegetables, sauces, liquids and much more. It is ideal for restaurants, bars, deli shops, catering, supermarkets, grocery stores and restaurants in general. It can prevent the products from oxidization, as well as corrosion and moisture, keeping the quality and freshness and prolonging the storage time.



Model	STEP SQUARE 450 DUAL-C	STEP SQUARE 550 DUAL-C
Overall Dimensions	680x570x1050 H	840x680x1050 H
Vacuum Chamber Dimensions	560x460x220 H	720x570x220 H
Sealing Bar	2 X mm 450 (1x5 mm)	2 X mm 550 (1x5 mm)
Vacuum Pump	Q = 20 m3/h OIL	Q = 60 m3/h OIL
Control Panel	Digit 9 PRG	Digit 9 PRG
Voltage	230 V/50-60 Hz	380 V/50-60 Hz
Item No.	49753450	49753550

Pharmaceutical Sealers

STEP EF803-500E Pharmaceutical Heat Sealer



STEP EF803-500E Pharmaceutical Heat Sealer is a specialized piece of equipment used for the heat sealing treatment of breathing bags and other materials at the manufacturing site.

Main Characteristics:

- Easy to use
- Fully suitable for high-temperature steam sterilization
- Automatic operation:
- Heat sealing integrity:
- Temperature control accuracy
- Adjustable cooling time

Specification

SPECIFICATIONS:	
Model	STEP EF803-500E Pharmaceutical Heat Sealer
Item No.	49860040
Heat sealing length	≤ 500mm
Sealing width	3mm
Operating temperature	100-200 °C
Voltage	220V/230V-50/60HZ
Power	500W
Weight	10.2kg

STEP UP 100-L automatic Medical sealing Machine

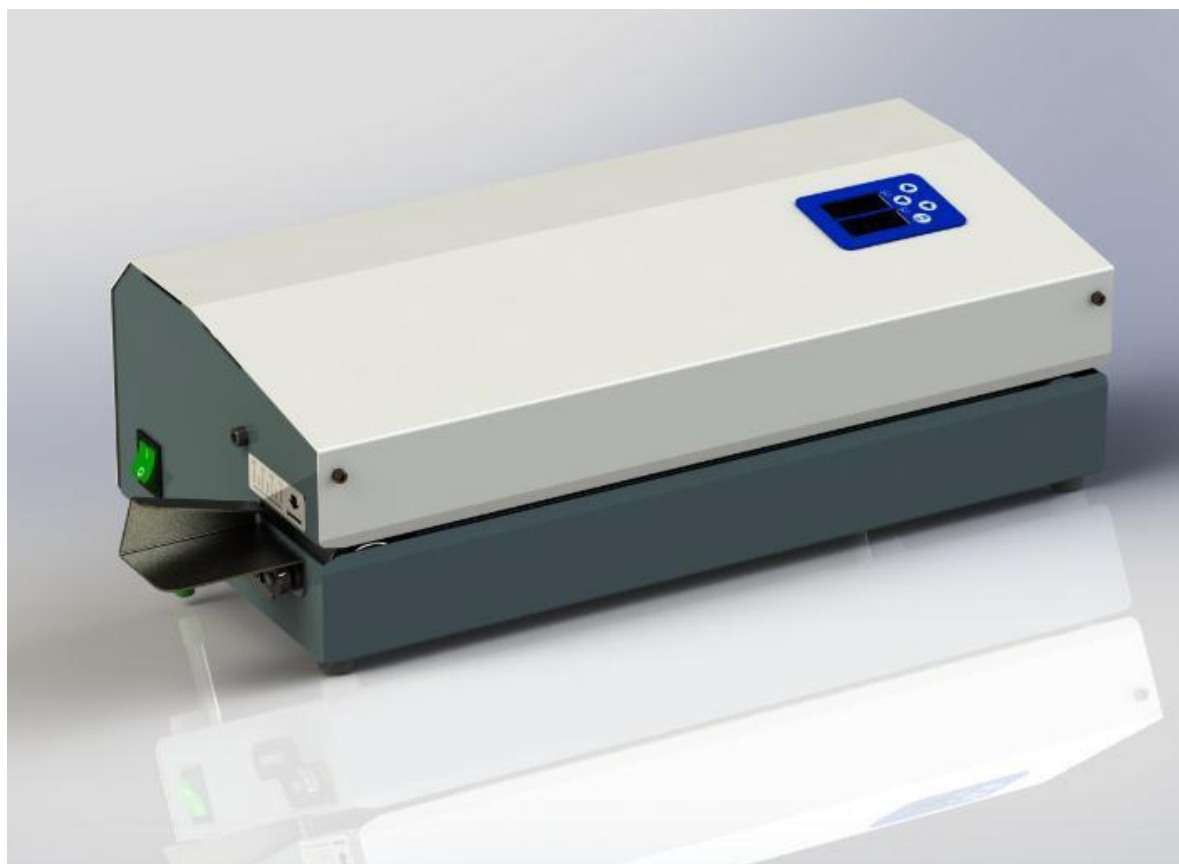

Main Characteristics:

- Auto-control function, continuous operation; substitution of manual sealing machine;
- Temperature controlled by a microcomputer, accuracy $\pm 1\%$, working temperature range 60~220°C;
- Fast heating, 40 seconds required from room temperature to 180°C;
- Adjustable fixed-force system, suitable for sealing paper-plastic bags, 3D paper-plastic bags and paper-paper bags;
- Advanced flat ceramic heating components, high-temperature stability, long life expectancy and high heat efficiency.

Specification

- Sealing speed 10m/min; Automatic controlled by sensor.
- Seal width 12mm; Voltage: 220V 50Hz
- Power: 500W
- Seal strength meets YY/T 0698.5-2009 requirement
- Weight: 15Kg
- Seal margin: 0~35mm adjustable
- Dimension: 482x242x157(mm)

Item no.: **49860010**

STEP UP 101-PD Printing Medical Sealing Machine

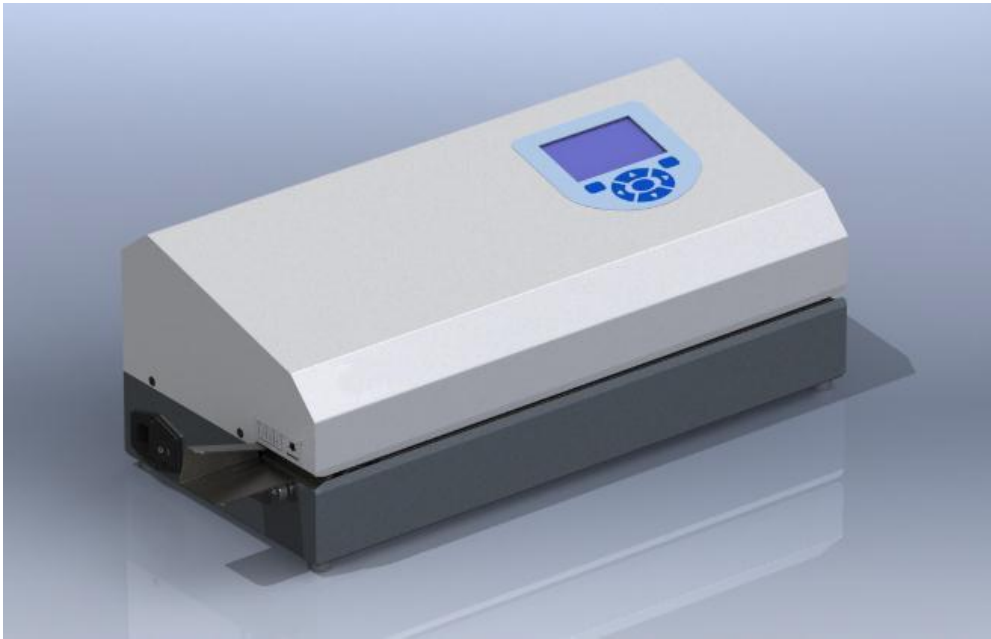

Main Characteristics:

- 4.3”(95x55mm) color liquid crystal screen, light-touch keyboard, internal clock;
- Temperature controlled by a microcomputer, accuracy $\pm 1\%$, working temperature range 60~220°C.
- Fast heating, 40 seconds required from room temperature to 180°C;
- Automatic temperature reduction operated by a fan connected to temperature control system, reducing the waiting time;
- Adjustable fixed-force system, suitable for sealing 3D paper-plastic bags and paper-plastic bags of any sickness;
- Advanced flat ceramic heating components, high-temperature stability, long life expectancy and high heat efficiency;
- Automatic fault detection and alarm.

Specification:

- Sealing speed 10m/min; automatic seal printing detection using light-control technique
- Seal width 12mm; Sealing strength meets YY/T 0698.6-2009 requirement
- Seal margin 0~35mm adjustable; machine shell material: spray carbon steel or 304 stainless steel
- Voltage: 220V 50Hz (optional); Maximum power: 500W
- Equipment dimension: 560x260x220(mm) Weight: 18kg

Printing System Features

- STEP UP 101-PD prints English, numbers and special symbols in YY 0466-2003 symbols Used for medical Equipment Labels, Signs and Information. It prints sterilizing date, expires date, lot number, operator, etc.
- Sterilizing and expire date auto adjust; Automatic faults alarms display during working;
- Adjust character font and style, easy to print more information or narrower bags;
- Print function can be disabled or partially activated;
- The system provides the required minimum width of the bag based on the content of print, easier for users to define the print content or select appropriate bag. Auto alarm when width is insufficient.

Item no.: **49860020**

STEP UP 101-T Touch Screen Medical Sealing Machine

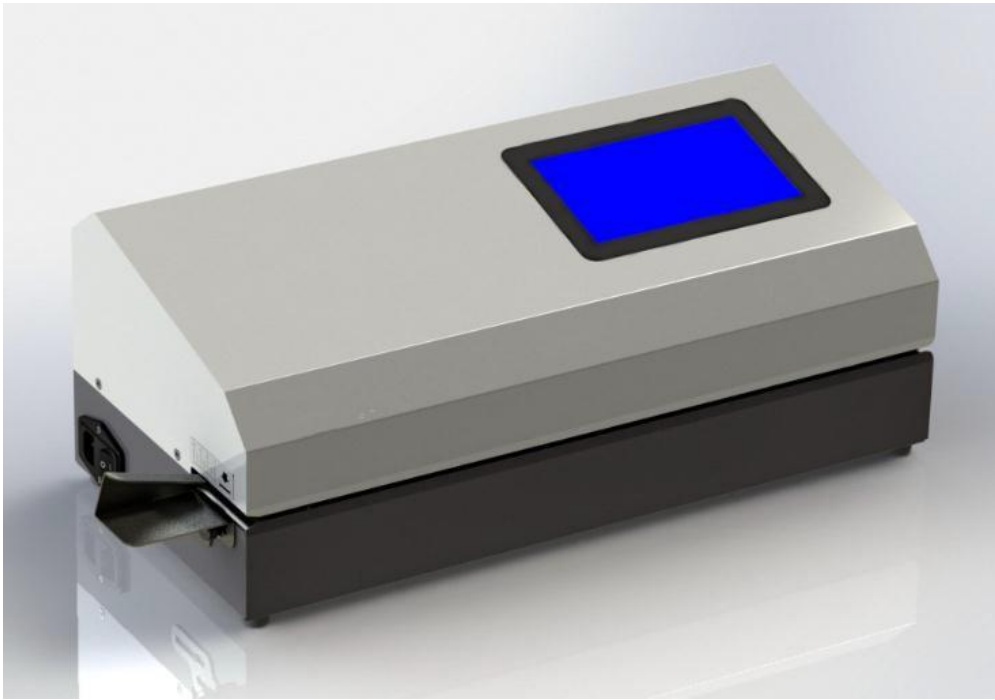

Main Characteristics:

- 8" Color Capacitive touch screen, graphical user interface built-in clock, and parameters can be set up with automatic storage function;
- Without connect to the computer it can set up or change the parameters such as operator, department, tool name and custom on the machine.
- With the self – printing parameters database, you can also use Wireless Router to record sealing parameters , for 8 million times to facilitate back the query;
- With a sealing cutter for precise statistics of the sealing numbers.
- With unique function of margin print, blank print, interval print and number print.
- Temperature controlled by a microcomputer, accuracy $\pm 1\%$, working temperature range 60-220°C.
- When temperature is out of $\pm 4^\circ\text{C}$ the machine will stop work to insure the quality of sealing and security
- Adjustable fixed-force system, suitable for sealing 3D paper-plastic bags and paper-plastic bags of any sickness;
- Automatic fault detection and alarm.
- Standby time and temperature is adjustable, it can recover to the work temperature in a short time.
- Advanced flat ceramic heating components, high-temperature stability, long life expectancy and high heat efficiency.

Technical parameters

Sealing speed: 10 ± 0.5 m/min

Seal margin: 0~35 mm adjustable

Temperature range: 60~220°C adjustable

Accuracy: $\leq 1\%$

Seal width: 12 mm

Power: 500 W

Dimension: 560x260x220mm

Voltage: 220V $\pm 10\%$ 50Hz

Printing system features

- STEP UP 101-T prints sterilizing date, expire date, lot number.
- Sterilizing and expire date auto adjust, Automatic faults alarm display during working.
- Prints function can be disable or partially activated
- The system provides the required minimum width of the bags based on the content of print, easier for users to define the print content or select appropriate bag.

Item no.:

49860030

STEP Extra Large Impulse Sealer Series

In cooperation with our supplier in Korea we can do a range of standard products and customer specific projects on Extra Large Impulse Sealers, Vacuum Sealers or Constant Heat sealers to fit the requirements your product and project sets.

Examples of machines from our Korean supplier.



Make a request and we will have the project evaluated, specified and quoted. If all details match the desired specification we hope we can server you within this project and product range



Standard machine range, from our Korean supplier.



Large Industrial Impulse Sealer

STEP 13010 TFD

Pneumatic Impulse Sealer Double

Sealing width. 1300mm

Sealing wire width: 10mm

Nmber of sealing wires: Top/Bottom

Pressure system: Pneumatic

Country og Origin: Taiwan

Item no.: 49911310



PE Polybags 25my

DIMENSION	DESCRIPTION	PCS / KRT	ITEM NO.
90 x 180mm	Ind side Dimensions Noted	1000	66090180
150 x 300mm		1000	66150300
180 x 360mm		1000	66180360
200 x 400mm		1000	66200400
250 x 500mm		1000	66250500
280 x 360mm		1000	66280360
300 x 600mm		1000	66300600
400 x 600mm		1000	66400600



PE Polybags 50my

90 x 180mm	Ind side Dimensions Noted	500	67090180
150 x 300mm		500	67150300
180 x 360mm		500	67180360
200 x 400mm		500	67200400
250 x 500mm		500	67250500
280 x 360mm		500	67280360
300 x 600mm		500	67300600
400 x 600mm		500	67400600

PE Polybags 70my

110 x 160 mm	Ind side Dimensions Noted	1000	67110167
150 x 300 mm		500	67150307
200 x 400 mm		500	67200404
250 x 500 mm		500	67250507
300 x 600 mm		500	67300607

STEP OPP Bags

OPP Bags with adhesive sealing flaps. Made with OPP and PE materials with a thickness of 0.04mm. Great for containing and transporting a wide variety of products such as foods, produce, ice, magazines, comic books, chemicals and waste.

Specifications:

Item Numbers	Bag Size with 30mm flap
67901100	843 x 1191
67901000	596 x 843
67900900	422 x 596
67900800	299 x 422
67900700	212 x 299 A4
67900600	150 x 212 A5
Item Numbers	Bag Size with 20mm flap
67900500	107 x 150
67900400	76 x 107
Item Numbers	Bag Size with 10mm flap
67900300	54 x 86
67900200	39 x 64
67900100	28 x 49



ZIPPER BAGS WITHOUT WRITING FIELD 50my

Ref Nr	Dimension	Description	Pieces / Carton	Item Number
1	40 x 60 mm	Zipper bags 50my without writing field. All bags have ø5mm hole for hanging. All dimensions are inside beneath zipper. Made of Polyethylen – PE. Environmentally neutral. Sure grip edge reinforcement.	1000	63040060
2	55 x 65 mm		4000	63055065
3	60 x 80 mm		1000	63060080
4	60 x 250 mm		1000	63060250
5	70 x 100 mm		1000	63070100
6	70 x 150 mm		1000	63070150
7	80 x 120 mm		1000	63080120
8	90 x 190 mm		1000	63090190
9	100 x 100 mm		1000	63100100
10	100 x 150 mm		1000	63100150
11	120 x 180 mm		1000	63120180
12	150 x 180 mm		1000	63150180
13	150 x 200 mm		1000	63150200
14	150 x 250 mm		1000	63150250
15	150 x 300 mm		4000	63150300
16	160 x 120 mm		4000	63160120
17	170 x 230 mm A5		1000	63170230
18	175 x 250 mm		1000	63175250
19	175 x 300 mm		1000	63175300
20	200 x 250 mm		4000	63200250
21	200 x 300 mm		4000	63200300
22	200 x 350 mm		4000	63200350
23	230 x 320 mm A4		1000	63230320
24	250 x 350 mm		1000	63250350
25	275 x 450 mm		1000	63275450
26	300 x 400 mm		1000	63300400

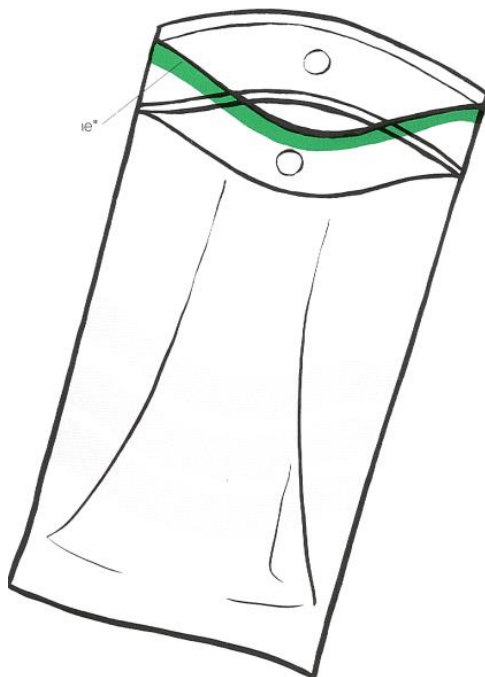

ZIPPER BAGS WITH WRITING FIELD 50my

27	40 x 60 mm	Zipper bags 50my with writing field. All bags have ø5mm hole for hanging. All dimensions are inside beneath zipper. Made of Polyethylene – PE. Environmentally neutral. Sure grip edge reinforcement.	1000	64040060
28	60 x 80 mm		1000	64060080
29	70 x 100 mm		1000	64070100
30	70 x 150 mm		4000	64070150
31	80 x 120 mm		1000	64080120
32	80 x 180 mm		4000	64080180
33	100 x 150 mm		1000	64100150
34	120 x 180 mm		1000	64120180
35	150 x 200 mm		1000	64150200
36	150 x 250 mm		1000	64150250
37	170 x 230 mm A5		4000	64170230
38	175 x 250 mm		1000	64175300
39	200 x 300 mm		1000	64200300
40	230 x 320 mm A4		1000	64230320

ZIPPER BAGS WITH WRITING FIELD 90MY

Ref Nr	Dimensions	Description	Pieces / Carton	Item Number
1	100 x 150 mm	Zipper bags 90my with writing field. All bags have ø5mm hole for hanging. All dimensions are inside beneath zipper. Made of Polyethyl-en – PE. Environmentally neutral. Sure grip edge reinforcement.	1000	64100151
2	150 x 200 mm		4000	64150204
3	150 x 250 mm		4000	64150254

STEP ZS-MINI Desktop Vacuum Packaging Machine

- Vacuum capacity: 004 m³ / h
- Duty cycle of 25 - 60 seconds / time
- Dimensions: 330 x 450 x 295mm
- Voltage: 230V-1-50Hz (other voltages optional)
- Power: 0,3 - 0,4 KW

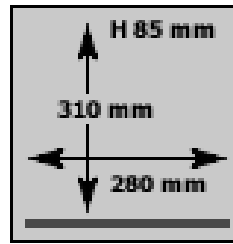

Optional H 130 mm

Item no.:

STEP ZS-PLUS Desktop Vacuum Packaging Machine

- Vacuum capacity: 008 m³ / h
- Duty cycle of 15 to 35 seconds / time
- Size: 330 x 450 x 295 mm
- Voltage: 230V-1-50Hz (other voltages optional)
- Power: 0,35 - 0,45 KW

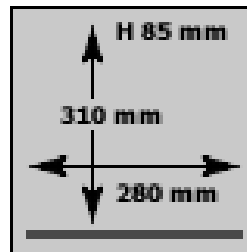

Optional H 130 mm

Item no.:

STEP ZS-350 Desktop Vacuum Packaging Machine

- Vacuum capacity: 016 m³ / h
- Duty cycle of 15 to 30 seconds / time
- Size: 450 x 525 x 385 mm
- Voltage: 230V-1-50Hz (other voltages optional)
- Power: 0,55 KW

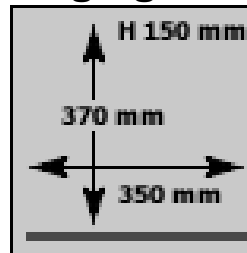

Item no.:

STEP ZS-420 Desktop Vacuum Packaging Machine

- Vacuum capacity: 20m³/h
- Duty cycle of 15 - 40 seconds /
- Dimensions: 500 x 530 x 490mm
- Voltage: 220V 50HZ
- Power: 1.0KW

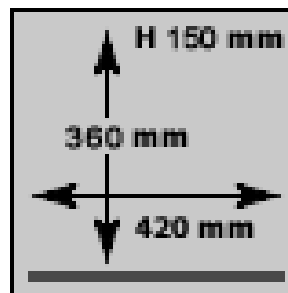

Item no.:

STEP ZS-420XL Desktop Vacuum Packaging Machine

- Vacuum capacity: 021 m³ / h
- Duty cycle :20-40 seconds /
- Size: 490 x 610 x 445 mm
- Voltage: 230V-1-50Hz (other voltages optional)
- Power: 0,75 - 1,0 KW

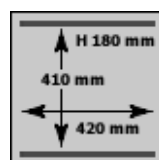
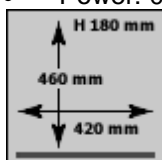

Standard 1 x 420 mm

Optional 2 x 420 mm



Single-Chamber Vacuum Packaging Machine

STEP DQ-420 Single-Chamber Vacuum Packaging Machine

- Vacuum capacity: 20m³ / h
- duty cycle of 15 - 40 seconds /
- Size: 500 x 530 x 1000mm
- Voltage: 220V 50HZ
- Power: 1.0KW

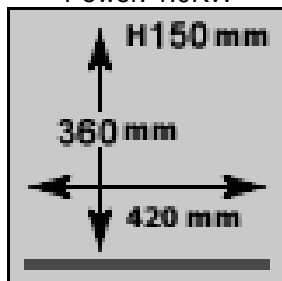

Standard 1 x 420 mm

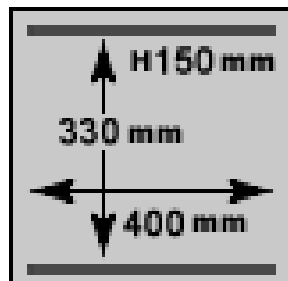

Optional 2 x 420 mm



STEP DQ-420XL Single-Chamber Vacuum Packaging Machine

- Vacuum capacity: 021 m³ / h
- Duty cycle :20-40 seconds /
- Size: 490 x 610 x 985 mm
- Voltage: 230V-1-50Hz
- Power: 0,75 - 1,0 KW

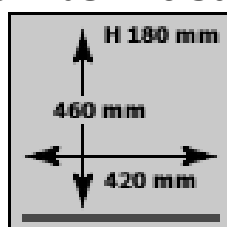

Standard 1 x 420 mm

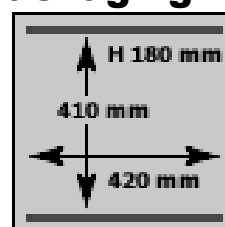

Optional 2 x 420 mm



STEP DQ-14.6 Single-Chamber Vacuum Packaging Machine

- Vacuum capacity: 040 m³ / h
- Duty cycle of 15 to 40 seconds / time
- Size: 780 x 660 x 970 mm
- Voltage: 400V-50Hz
- Power: 2,3 - 3,2 KW

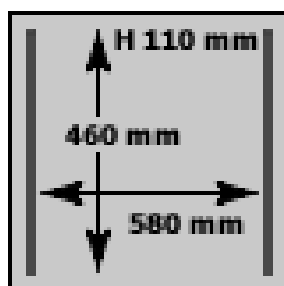

STEP DQ-520 Single-Chamber Vacuum Packaging Machine

- Vacuum capacity: 063 m³ / h
- Duty cycle of 15 to 40 seconds / time
- Size: 700 x 690 x 1030 mm
- Voltage: 400V-50Hz (other voltages optional)
- Power: 2,4 - 3,5 KW

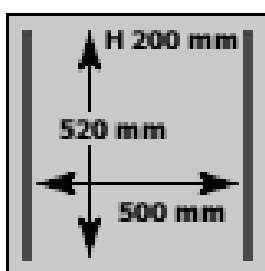

Standard 2 x 520 mm

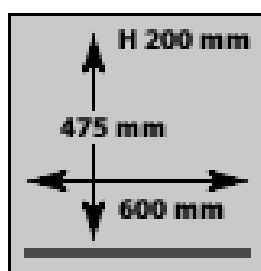

Optional 1 x 600 mm



STEP DQ-800 Single-Chamber Vacuum Packaging Machine

- Vacuum capacity: 100 m³ / h
- Duty cycle of 15 to 40 seconds / time
- Size: 900 x 820 x 1070 mm
- Voltage: 400V-50Hz (other voltages optional)
- Power: 3,0 - 5,0 KW

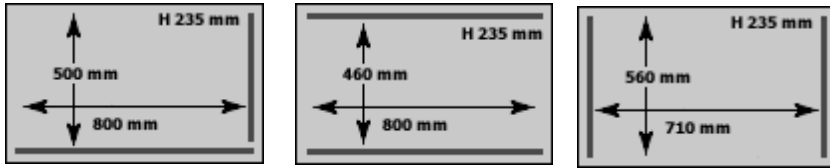

Standard 500 - 800 mm Selectable 2 x 800 mm or 2 x 500mm



STEP DQ-900 single-chamber vacuum packaging machine

- Vacuum capacity: 100 m³/h
- Duty cycle of 15 to 40 seconds/cycle
- Size: 900 x 820 x 1070mm
- Voltage: 400V-50Hz
- Power: 3,0 - 5,0 KW

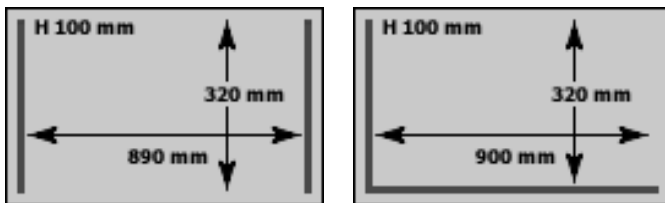

Standard: 2 x 320 mm Optional: 320 - 900 mm



Double Chamber Vacuum Packaging Machines

STEP SQ-400 Double Chamber Vacuum Packaging Machine

- Vacuum capacity: 063 m³/h
- Duty cycle of 15 to 40 seconds/cycle
- Size: 1545 x 790 x 1090mm
- Voltage: 400V-50Hz
- Power: 3,3 - 4,5KW

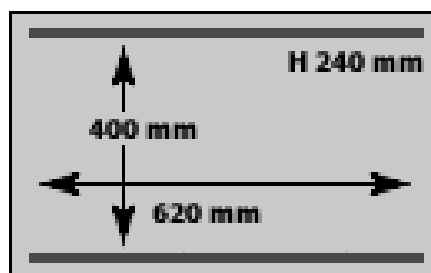

STEP SQ-500 Double Chamber Vacuum Packaging

- Vacuum capacity: 100 m³/h
- Duty cycle of 15 to 40 seconds/cycle
- Size: 1545 x 900 x 1175mm
- Voltage: 400V-50Hz
- Power: 3,5 - 5,3KW

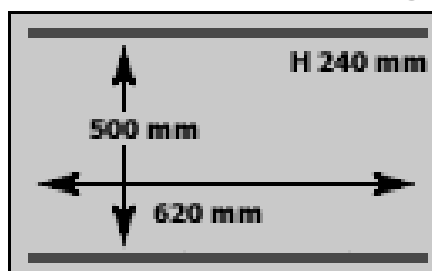

STEP ZD-550 Double Chamber Vacuum Packaging Machine

- Vacuum capacity: 40m³ / h
- duty cycle of 15 -40 seconds /
- size: 1310 x 800 x 1150mm
- Voltage: 220V/50HZ (380V/50HZ)
- Optional power: 2.0KW

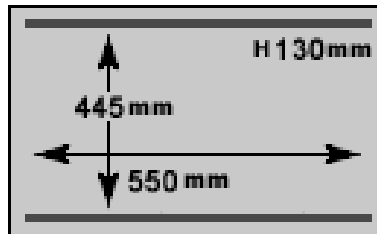

STEP SQ-600 Double Chamber Vacuum Packaging Machine

- Vacuum capacity: 63m³ / h
- duty cycle of 15 - 40 seconds /
- Dimensions: 1310 x 800 x 1150mm
- Voltage: 400V 50HZ
- Power: 2.2KW

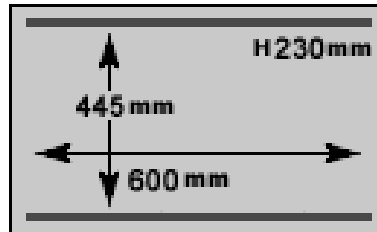

STEP SQ-750 Double Chamber Vacuum Packaging Machine

- Vacuum capacity: 160 m³ / h
- Duty cycle of 15 to 40 seconds / time
- Size: 1545 x 1150 x 1180 mm
- Voltage: 400V-50Hz
- Power: 5,5 - 9,0 KW

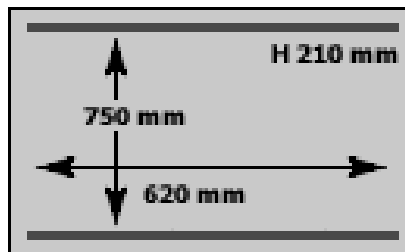

STEP SQ-850 Double Chamber Vacuum Packaging Machine

- Vacuum capacity: 300 m³ / h
- Duty cycle of 10 - 30 seconds / time
- Size: 1980 x 1230 x 1180 mm
- Voltage: 400V-50Hz
- Power: 7,0 - 9,0 KW

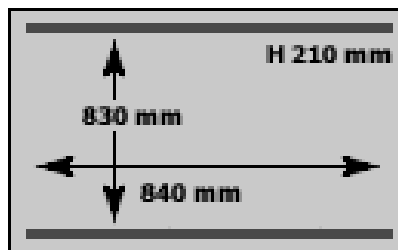

STEP SQ-950 Double Chamber Vacuum Packaging Machine

- Vacuum capacity: 300 m³ / h
- Duty cycle of 15 to 40 seconds / time
- Size: 2420 x 1210 x 1130 mm
- Voltage: 400V-50Hz (other voltages optional)
- Power: 7,0 - 9,0 KW

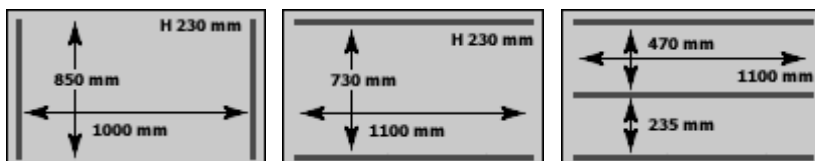

Standard: 2 x 1100 mm Optional: 2 x 850 mm Optional: 3 x 1100 mm

